



KA1027-01 UxV/35™ Prototype PCB Datasheet

Links to Contents of This Datasheet

[Overview of the UxV/35™ Standard](#)

[Board Categories and Additional Boards](#)

[Suggested Pin Assignments for UAVs, UGVs, and USVs](#)

[Country of Origin](#)

Description of the Board

This interoperability board provides a generous prototype area for creating a custom UxV/35™ module.

Custom circuitry or modules can be easily integrated into the UxV/35™ stack.

All UxV/35™ pins are brought to the prototype area for easy solder connection.

It has normal UxV/35™ connectors so it can be placed anywhere in the stack.

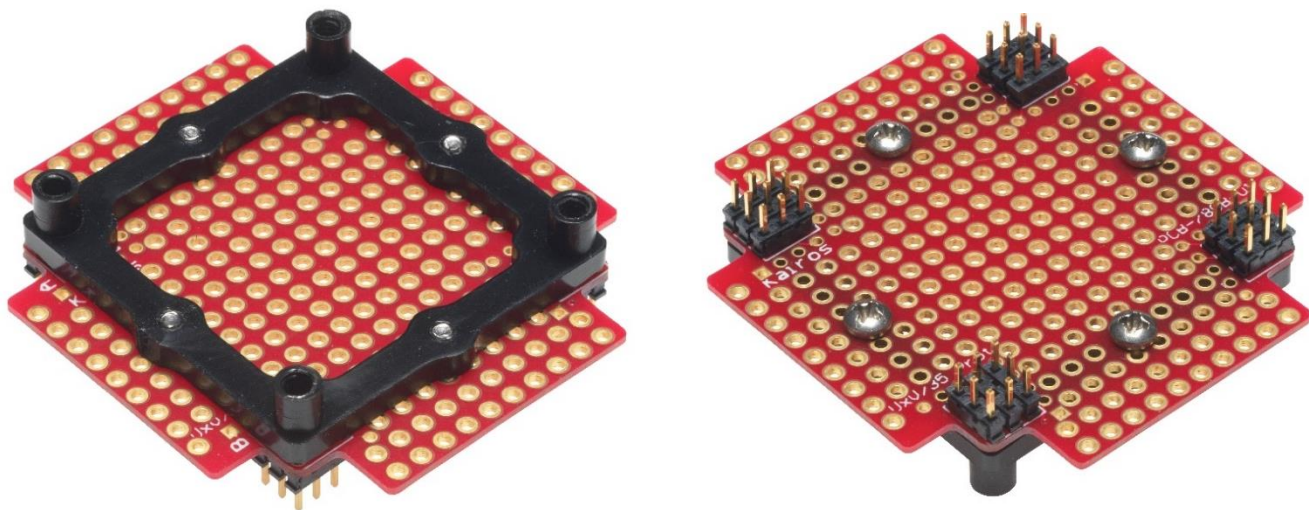



Overview of the UxV/35™ Standard

UAVs, UGVs, and USVs consist of multi-disciplinary components, such as electronic modules, wiring harnesses, and structural members. The UxV/35™ Standard provides a modular assembly approach for uncrewed systems that minimizes wiring and increases the success rate and speed of assembly. The goal is to bring order and interoperability to these common components.

The UxV/35™ Standard, as outlined, is compatible with open-source flight and vehicle controllers from multiple vendors such as ArduPilot and Betaflight. These UxV/35™ compatible components can include functions such as:

Flight controllers	Motive means (motors)	User interfaces
Electronic speed controls (ESC)	Communications	Enclosures & structures
Power distribution	Video systems	System testing
Global orientation	Payload systems	Local orientation

Stacking for Rapid Assembly and Interoperability

Instead of requiring soldering for connecting with other boards, UxV/35™ boards snap together into “stacks” through pin connectors. They can also be used in a planar configuration. These platforms spread out the stack into a flatter format. The precision design of the connecting pins between stacked boards ensures rapid assembly and reliable performance.

The process involves:

- unpacking a set of UxV/35™ compatible boards,
- stacking them as needed, and
- configuring their software.

After installing the batteries, the craft can operate within minutes.

Board Categories

The boards are grouped into five categories:

- [UxV/35™ Mission Boards](#) control the movement and behavior of your UAV, UGV, or USV.
- [UxV/35™ Platform and Power Boards](#) direct power to any components in the stack.
- [UxV/35™ Stack Management Boards](#) let you rotate, reverse, or rearrange your stack horizontally or vertically to best fit the shape or function of your craft.
- [UxV/35™ Interoperability Boards](#) adapt the connectors on open-source boards from multiple vendors.
- [UxV/35™ Test Boards](#) enable you to test the boards and their configurations at the bench or in the field.

For a description of currently available UxV/35™ boards in each category, please see Kairos82nd.com.

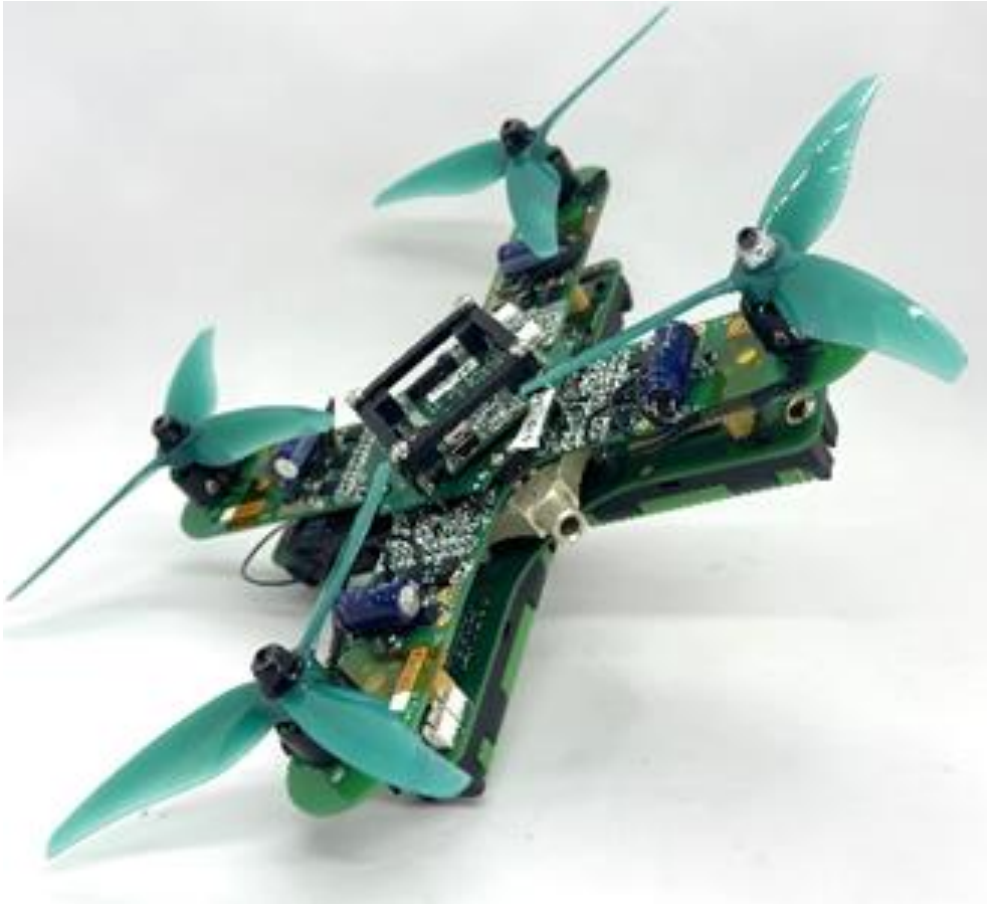

Examples of Stacked UxV/35™ Boards

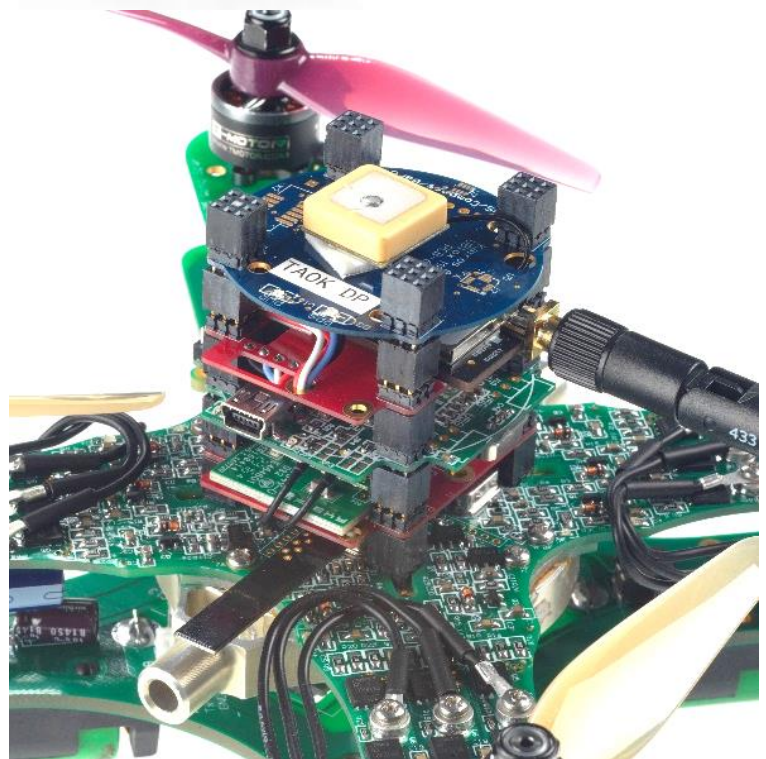



Defining the UxV/35™ standard

The UxV/35™ Bus is divided into 4 quadrants, located at the 4 corners of the 30.5mm square board (ad hoc industry standard). The four quadrants are assigned signal groups as follows:

- A Servo Signals
- B I2C and General-Purpose Signals
- C Power and Power Monitoring, Analogs, Safety
- D Serial Signals

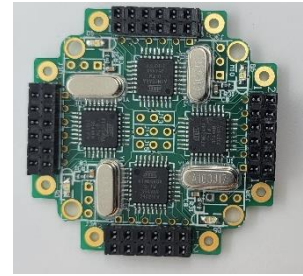
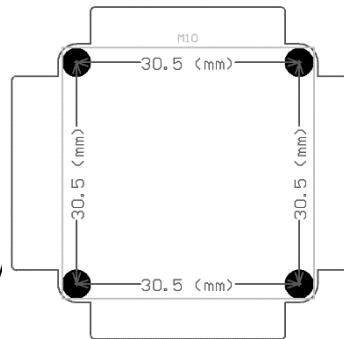

The groups are arranged on the board in the four corners. Each of the groups is assigned a letter in the range A – D. The groups are assigned as follows:

- Group A Upper Left
- Group B Upper Right
- Group C Lower Left
- Group D Lower Right

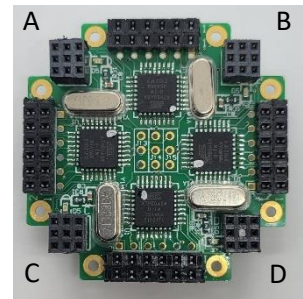
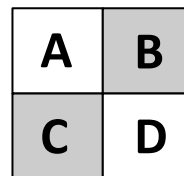

With Kairos assistance, Samtec developed a set of connectors based on a 2mm grid in a 3 x 3 pinning format. Groups A, B, and C use the full 9-pin load. Group D uses an 8-pin load. Without the middle pin, Group D becomes the key.

These connectors stack and nest forming a columnar bus of 9 pins. The concept is similar to that of PC/104. Samtec assigned these P/Ns:

Samtec P/N	Connector Type
ASP-232112-05	8-pin loaded, 2mm 3x3 format, center key
ASP-232112-06	9-pin loaded, 2mm 3x3 format

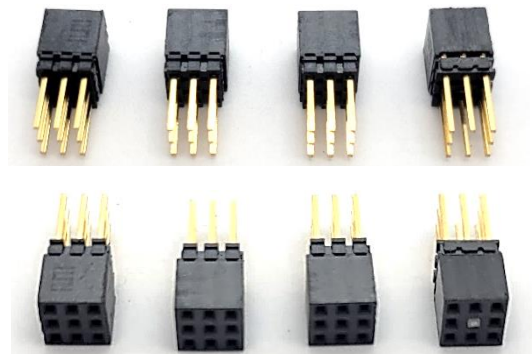

Each group is numbered 1 through 9, left to right, starting in the upper left, and proceeding across and down. The group precedes the pin number when referencing a pin. The pins of the four groups are numbered as follows:

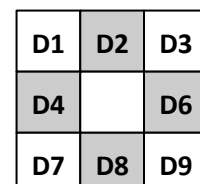
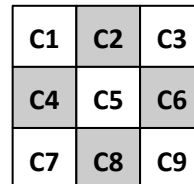
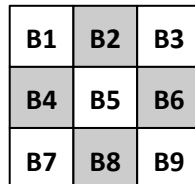
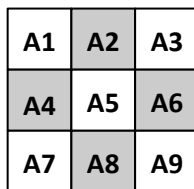



Each of the group's A-D are assigned signals that relate to the control and monitoring of unmanned ground, air, and surface vehicles. The group assignments are as follows:

- A1 – Servo Output 1 Assigned to S1
- A2 – Servo Output 2 Assigned to S2
- A3 – Servo Output 3 Assigned to S3
- A4 – Servo Output 4 Assigned to S4
- A5 – Servo Output 5
- A6 – Servo Output 6
- A7 – Servo Output 7
- A8 – Servo Output 8
- A9 – SBUS Signal Serial Receive Channel E (input to FC)

- B1 – Primary I2C Clock (SCL)
- B2 – Primary I2C Data (SDA)
- B3 – Secondary I2C Clock (SCL)
- B4 – Secondary I2C Data (SDA)
- B5 – GP1 Video In from Camera or Secondary SPI MISO
- B6 – GP2 Video Out from Text Overlay or Secondary SPI MOSI
- B7 – GP3 Serial Transmit Channel F (output from FC) or Secondary SPI SCLK
- B8 – GP4 Serial Receive Channel F (input to FC) or Secondary SPI Chip Select #1
- B9 – GP5 Serial Transmit Channel E (output from FC) or Secondary SPI Chip Select #2

- C1 – Battery Voltage (3S or 4S) Battery +
- C2 – Ground Battery –
- C3 – Radio Signal Strength Indicator 0-3.3v (RSSI)
- C4 – Analog Current Usage Indicator, 0-3.3v (Ain)
- C5 – Return to Home
- C6 – 3.3V Generated from Battery input (1 amp)
- C7 – Reset
- C8 – Pause
- C9 – +5V Generated from Battery input (1 amp)

- D1 – Serial Transmit Channel A (output from FC)
- D2 – Serial Receive Channel A (input to FC)
- D3 – Serial Transmit Channel B (output from FC)
- D4 – Serial Receive Channel B (input to FC)
- D5 – Pin not Present, used as key
- D6 – Serial Transmit Channel C (output from FC)
- D7 – Serial Receive Channel C (input to FC)
- D8 – Serial Transmit Channel D (output from FC)
- D9 – Serial Receive Channel D (input to FC)





Suggested Pin Assignments for UAV, UGV, and USV

Although autopilots for uncrewed systems have significant configuration abilities (mostly I/O), these suggested assignments enable lower-skilled interoperability:

UAV – Quadcopter

- S1 Forward Left Rotor, CW
- S2 Rear Left Rotor, CCW
- S3 Rear Right Rotor, CW
- S4 Front Right Rotor, CCW
- TxC/RxC GPS
- TxB/RxB MavLink
- TxA/RxA Commander/Swarm
- I2CA Baro, Compass

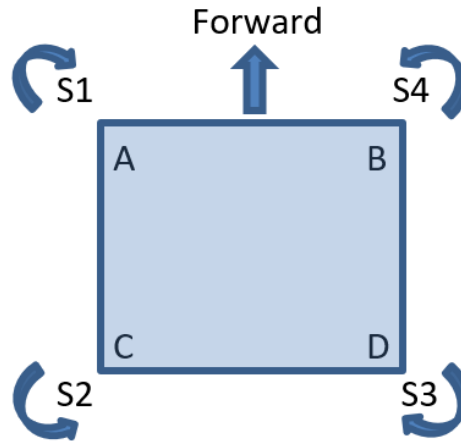

UAV – Fixed Wing

- S1 Elevator
- S2 Flaperon Right
- S3 Flaperon Left
- S4 Throttle ESC
- TxC/RxC GPS
- TxB/RxB MavLink
- I2CA Baro, Compass
- TxA/RxA Commander

UGV

- S1 Steering
- S2 Throttle
- S3 Brake
- S4 Transmission
- TxC/RxC GPS
- I2CA Compass
- TxA/RxA Commander

USV

- S1 Steering
- S2 Throttle
- TxC/RxC GPS
- I2CA Compass
- TxA/RxA Commander

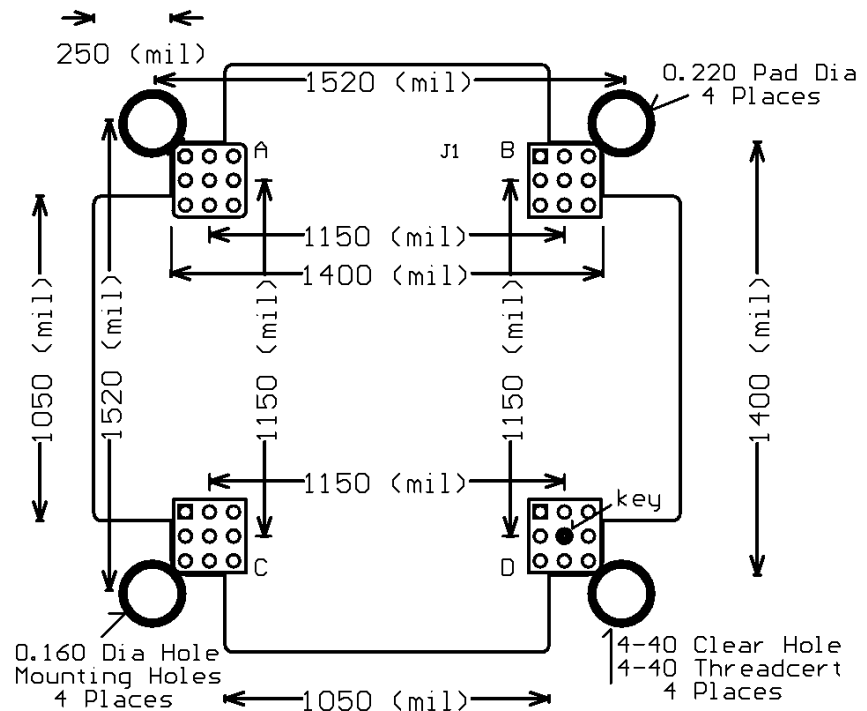



Country of Origin

Kairos82nd uses the color of the PCB to assist in the determination of country of origin. ***One hundred percent of Kairos82nd UxV/35™ components are manufactured in Salt Lake City, Utah. The PCBs are sourced and assembled locally. The firmware on these boards is source code managed by Kairos82nd or is available as open source.***

All Kairos82nd UxV/35™ PCB boards that are **Blue** or **Green** are built with components sourced from domestic and global foundries. Any firmware is owned, managed, or controlled by Kairos82nd.

Any of our PCBs that are **Red** indicate that they may contain components from a country of origin that is not acceptable for usage by the U.S. Government without a waiver. All interoperability boards are **Red** because they can be adapted to and used with third party boards where Kairos82nd cannot manage the country of origin.

Warranty

Kairos82nd warrants its products for one (1) year from date of purchase. Kairos82nd will repair or replace, at Kairos82nd's discretion, products found to be defective. Repair or replacement will not be covered for a product that has been physically damaged or where power was misapplied.

Legal Disclaimer Notice

TO THE FULLEST EXTENT PERMITTED BY LAW, IN NO EVENT WILL KAIROS82ND BE LIABLE FOR ANY SPECIAL, COLLATERAL, INDIRECT, PUNITIVE, INCIDENTAL, CONSEQUENTIAL, OR EXEMPLARY DAMAGES IN CONNECTION WITH OR ARISING OUT OF THIS CONTRACT OR THE USE OF THE ITEMS, REGARDLESS OF WHETHER KAIROS82ND HAS BEEN ADVISED OF THE POSSIBILITY OF SUCH DAMAGES.

Kairos82nd reserves the right to make any revisions, enhancements, improvements, corrections, or any other modifications to the products (both hardware and software) at any time and without notice. Users are solely responsible for their selection and use of the hardware and software and any application of the products described in them. User agrees to indemnify and hold Kairos82nd harmless against all liabilities, costs, damages, or other losses arising out of their use.

Kairos82nd products are not designed, manufactured, or intended for use in environments requiring fail safe performance, such as in the operation of nuclear facilities, aircraft navigation or communication systems, air traffic control, weapons systems, or safety-critical applications (including life support systems and other medical devices), in which the failure of the products could lead directly to death, personal injury or severe physical or environmental damage. Kairos82nd specifically disclaims any express or implied warranty of fitness for these applications and accepts no liability for use or inclusions of Kairos82nd products in these applications.

Copyrights

© Copyright 2023, Kairos82nd. All rights reserved. All text, pictures and graphics are protected by copyrights. No copying is allowed without written approval from Kairos82nd.